

Delfin

Datenblatt 1



Standard Anschlussstypen:

A ↓ 440÷2000:



A ↓ 440÷640:

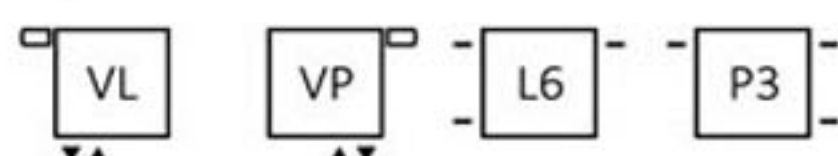

A ↓ 1800÷2000:

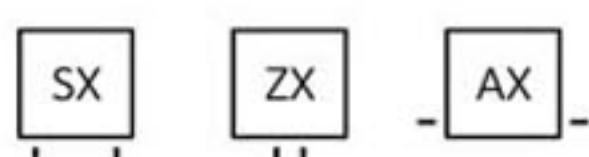

Elektroheizkörper siehe Seite 487. A ↓ 440÷640:



Weitere mögliche Anschlussstypen:

A ↓ 440÷2000:



A ↓ 440÷640:

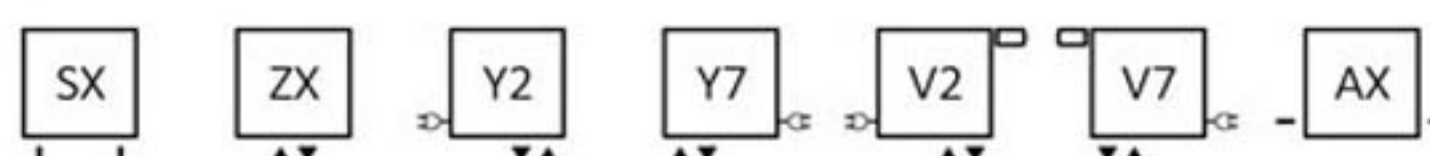

A ↓ 1800÷2000:



Technische Daten:

Betriebsdruck: 800 kPa

Maximale Betriebstemperatur: 95°C

A ↓ [mm]	B ↔ [mm]	C1 [mm]	C2 [mm]	C3 [mm]	C4 [mm]	75/65/20°C [W]	55/45/20°C [W]	☺ [W]	D [mm]	E [mm]	F [mm]	H [dm³]	📖 [kg]
440	820	50	780	400	820	705	370	800	710	400	20	6,41	14,30
440	1020	50	980	400	1020	885	465	800	910	400	20	8,01	17,82
440	1220	50	1180	400	1220	1061	556	1000	1110	400	20	9,60	21,34
540	820	50	780	500	820	846	442	800	710	500	20	7,61	16,97
540	1020	50	980	500	1020	1057	553	1000	910	500	20	9,50	21,16
540	1220	50	1180	500	1220	1264	661	1200	1110	500	20	11,39	25,35
640	820	50	780	600	820	986	514	1000	710	600	20	8,80	19,65
640	1020	50	980	600	1020	1233	644	1200	910	600	20	10,99	24,50
640	1220	50	1180	600	1220	1458	760	1500	1110	600	20	13,19	29,36
1800	500	50	460	1760	500	1403	717	-	360	1760	20	13,61	30,48
1800	580	50	540	1760	580	1623	830	-	440	1760	20	15,87	35,52
2000	500	50	460	1960	500	1556	802	-	360	1960	20	15,04	33,68
2000	580	50	540	1960	580	1774	909	-	440	1960	20	17,55	39,26

Verfügbare Größen:

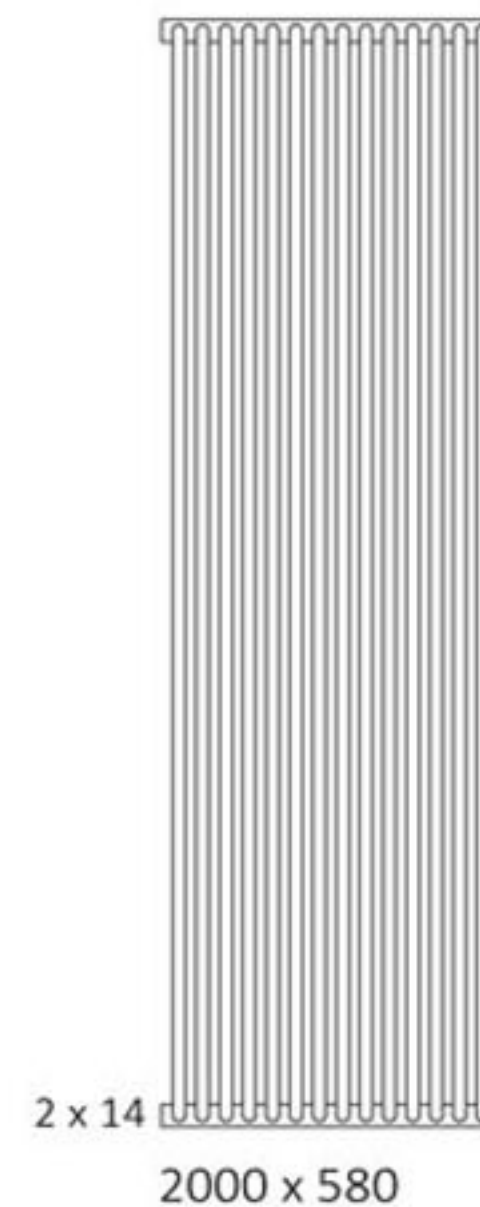
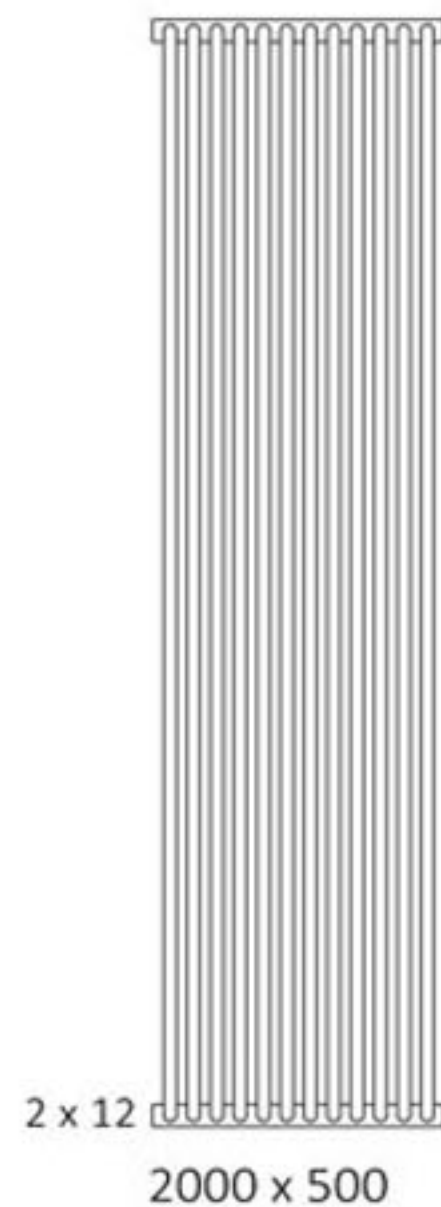
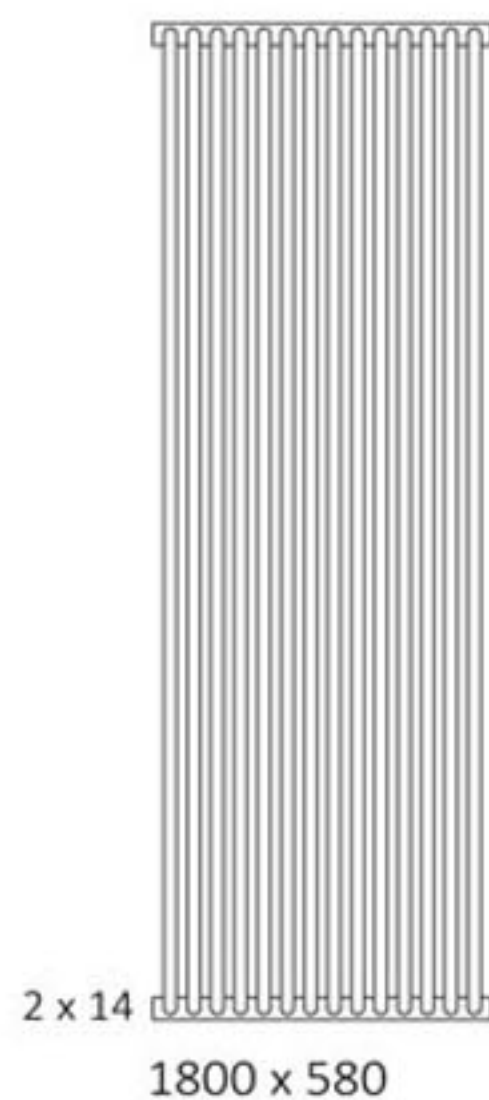
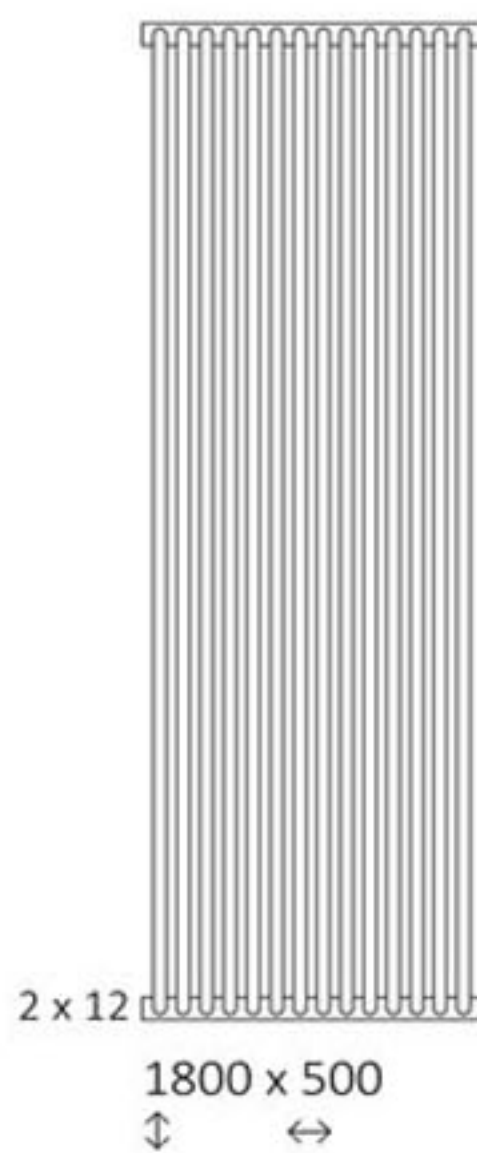
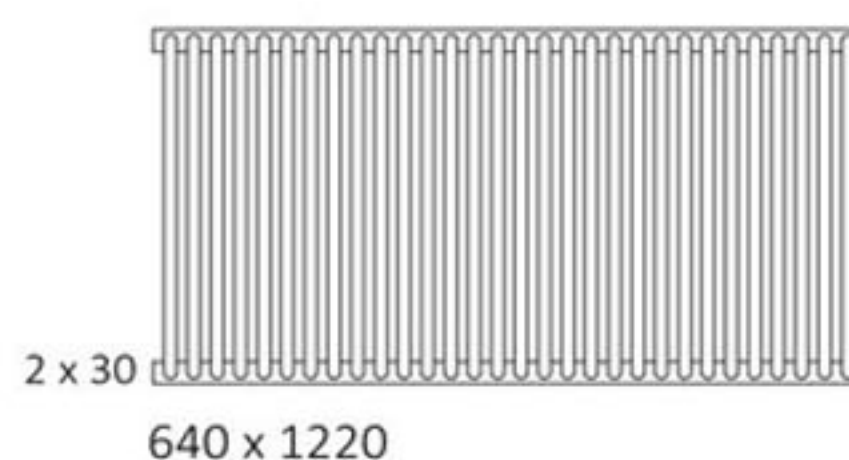
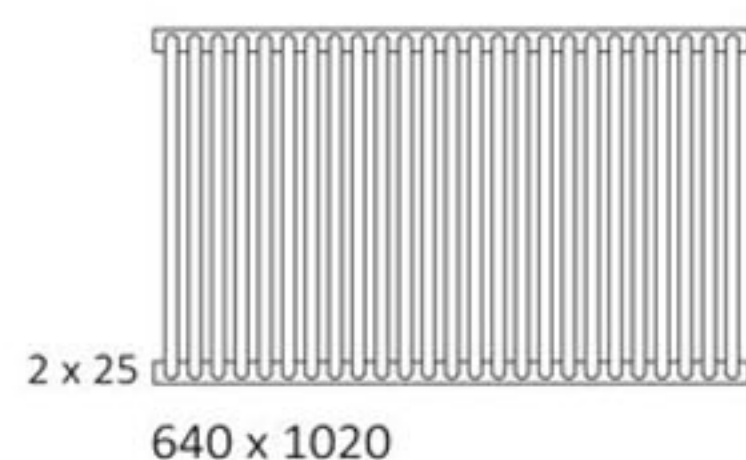
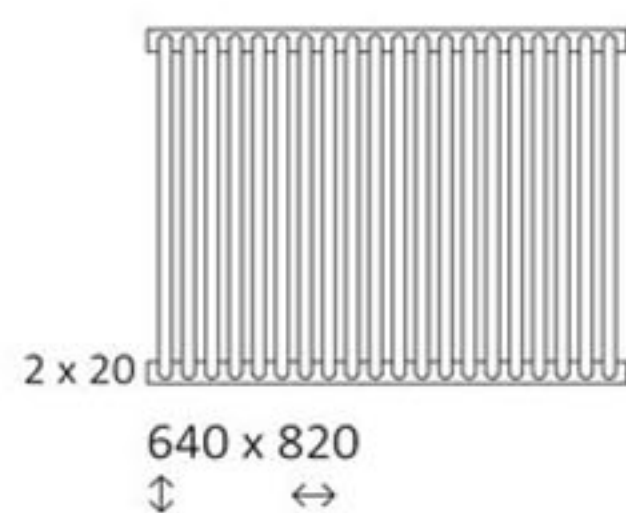
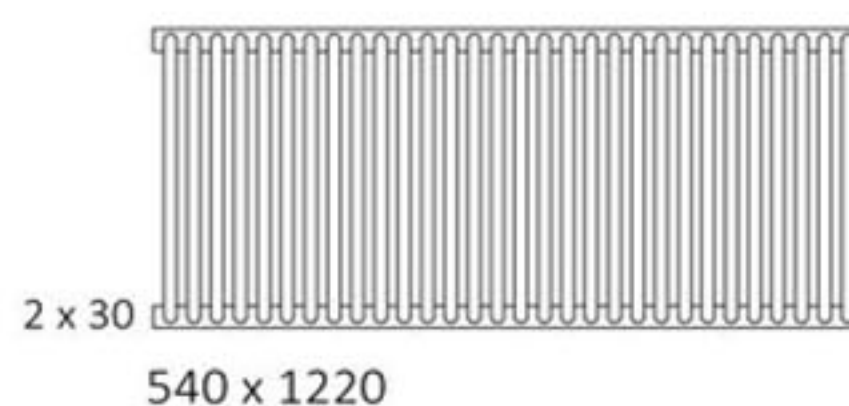
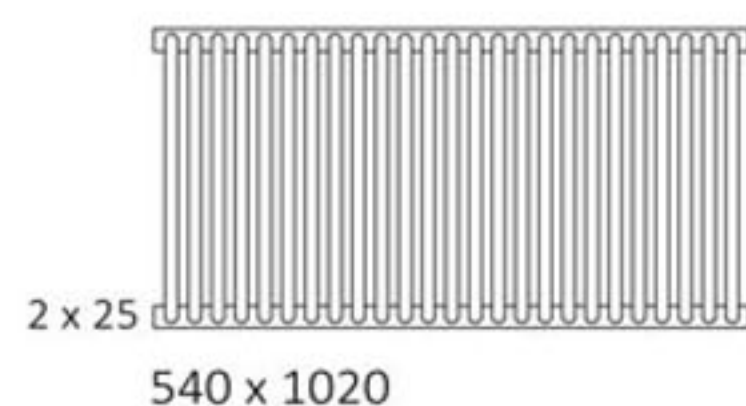
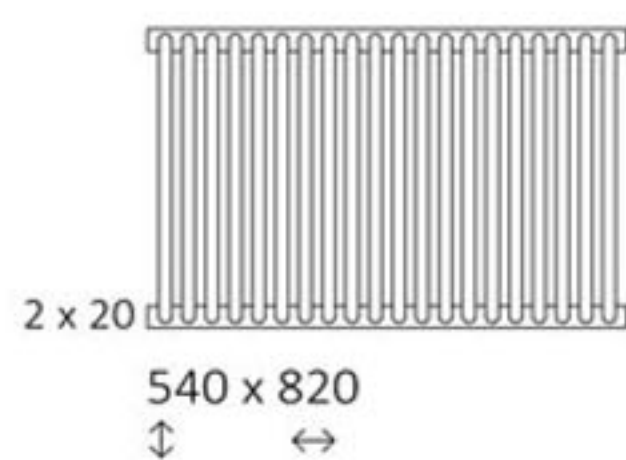
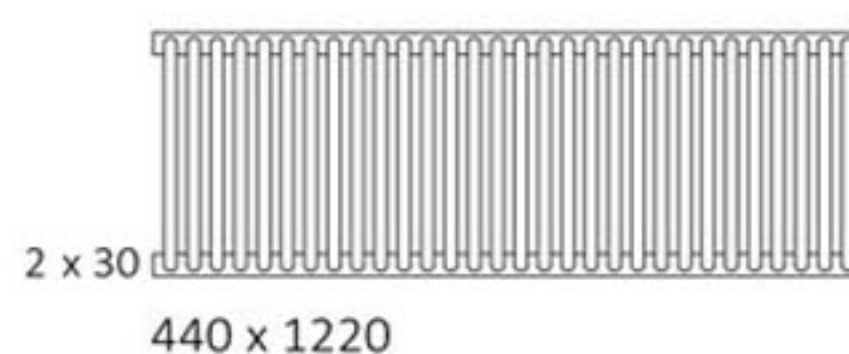
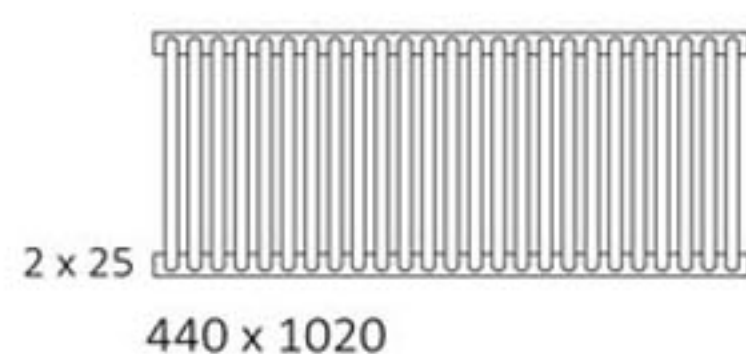
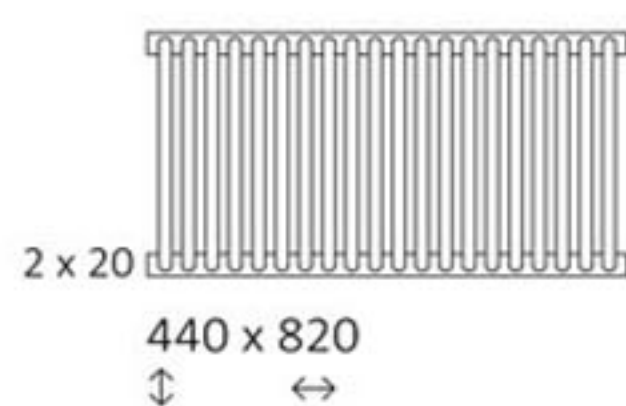

Delfin

Technische Zeichnung 1

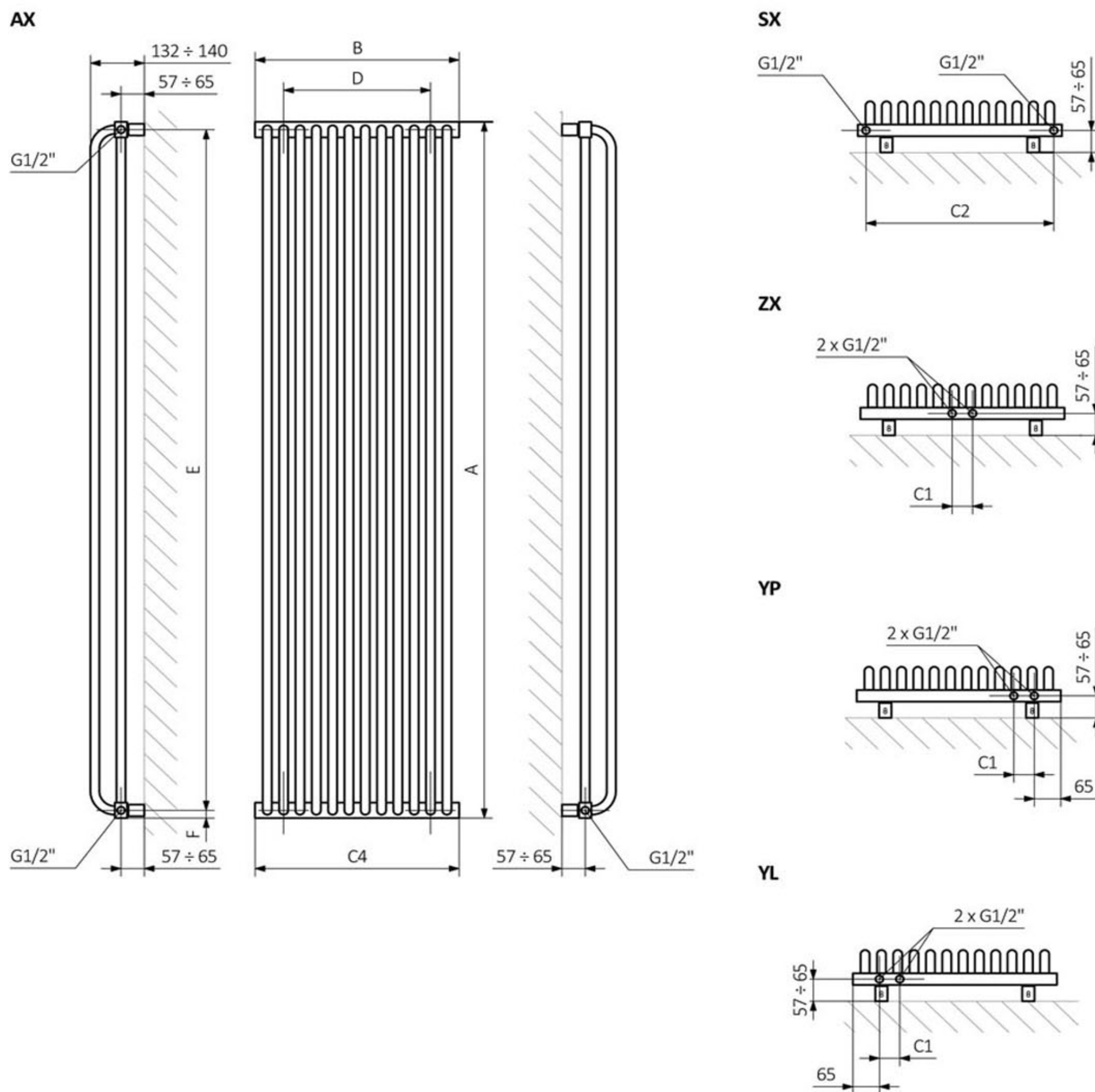

A - Höhe B - Breite C1-C5 - Anschlussabstand D - horizontaler Wandhalterungsabstand E - Vertikaler Wandhalterungsabstand F - Abstand von der Achse der unteren Wandhalterung bis Unterkante des Kollektors

Kollektor:

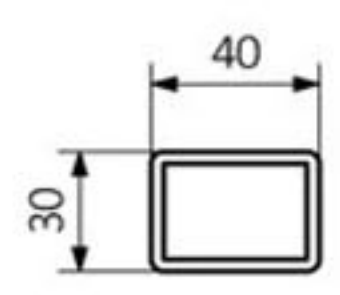

Rohr:

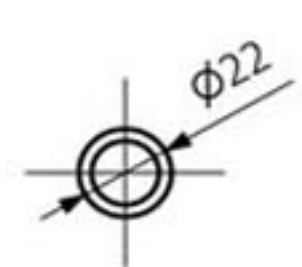

L6

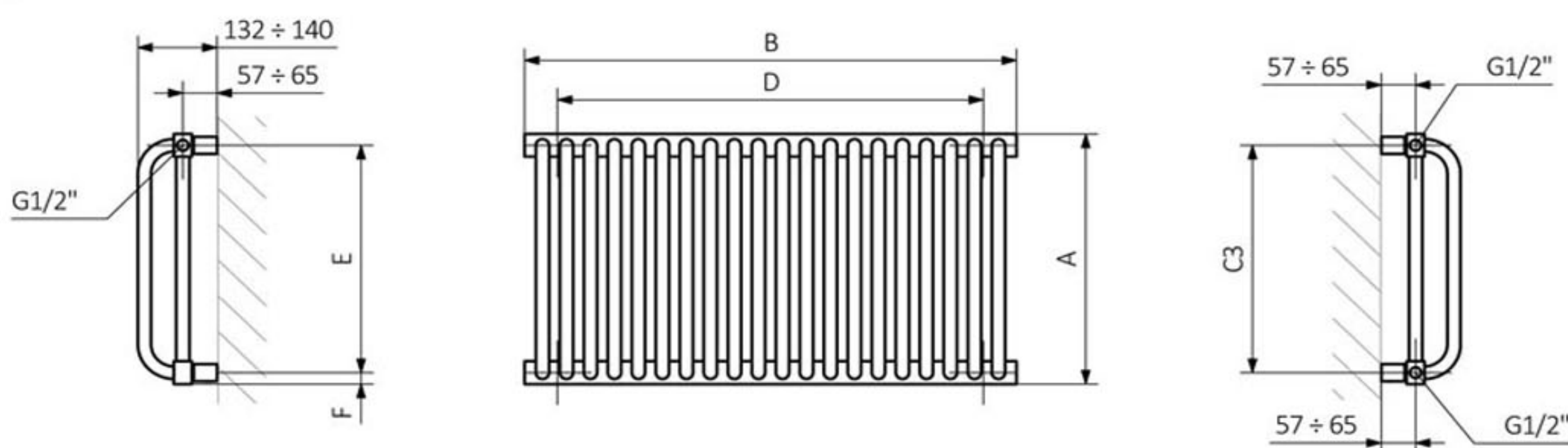

P3

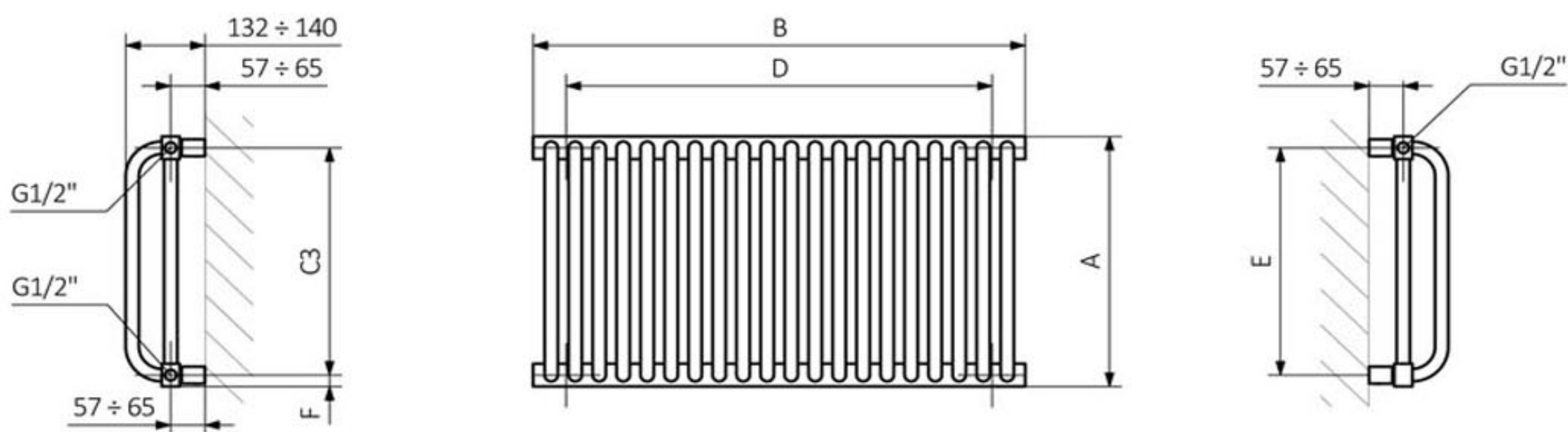

YL

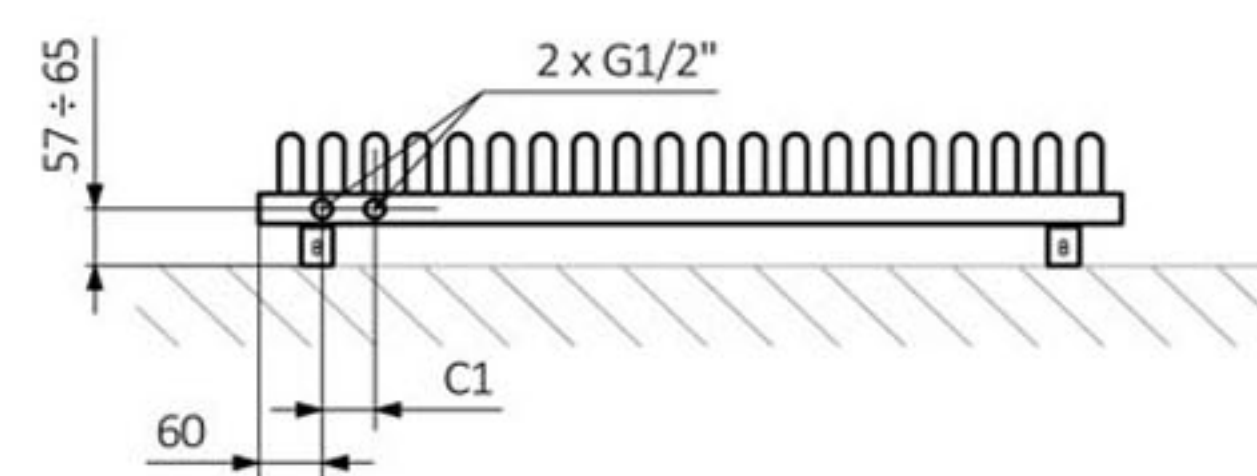

YP

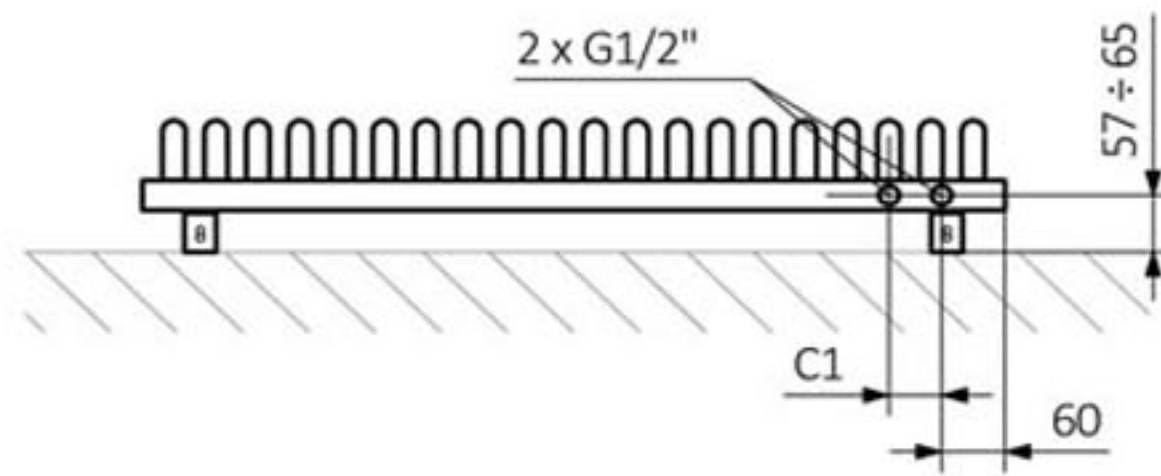

A - Höhe B - Breite C1-C5 - Anschlussabstand D - horizontaler Wandhalterungsabstand E - Vertikaler Wandhalterungsabstand F - Abstand von der Achse der unteren Wandhalterung bis Unterkante des Kollektors

Kollektor:

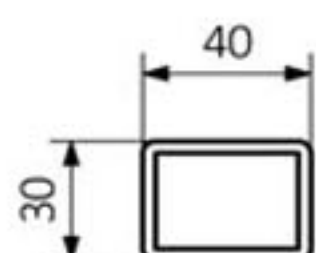

Rohr:

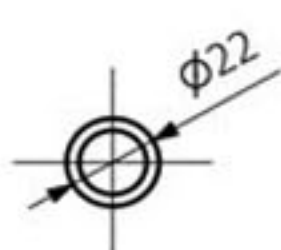

Delfin

Technische Zeichnung 3



VL

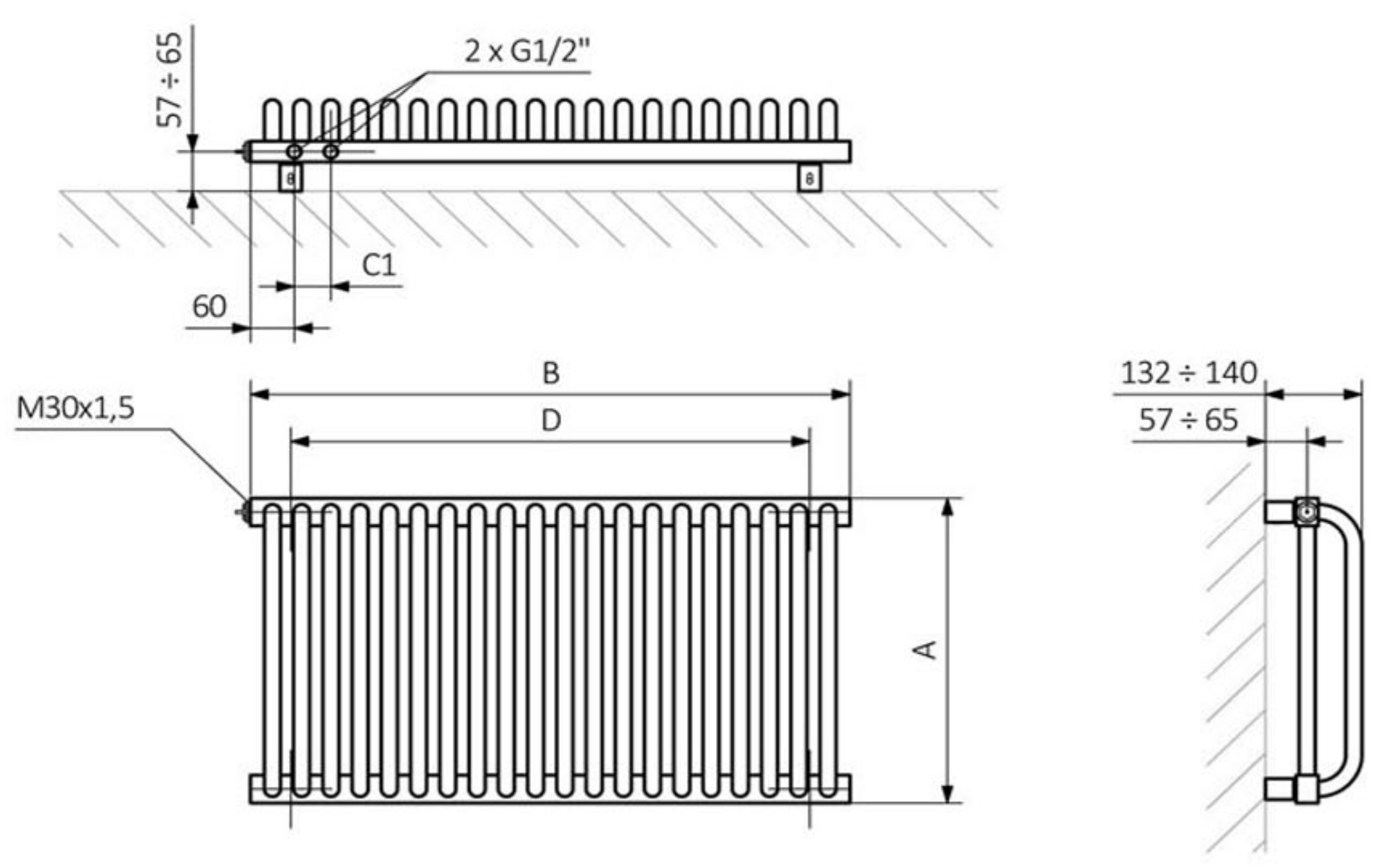

VP

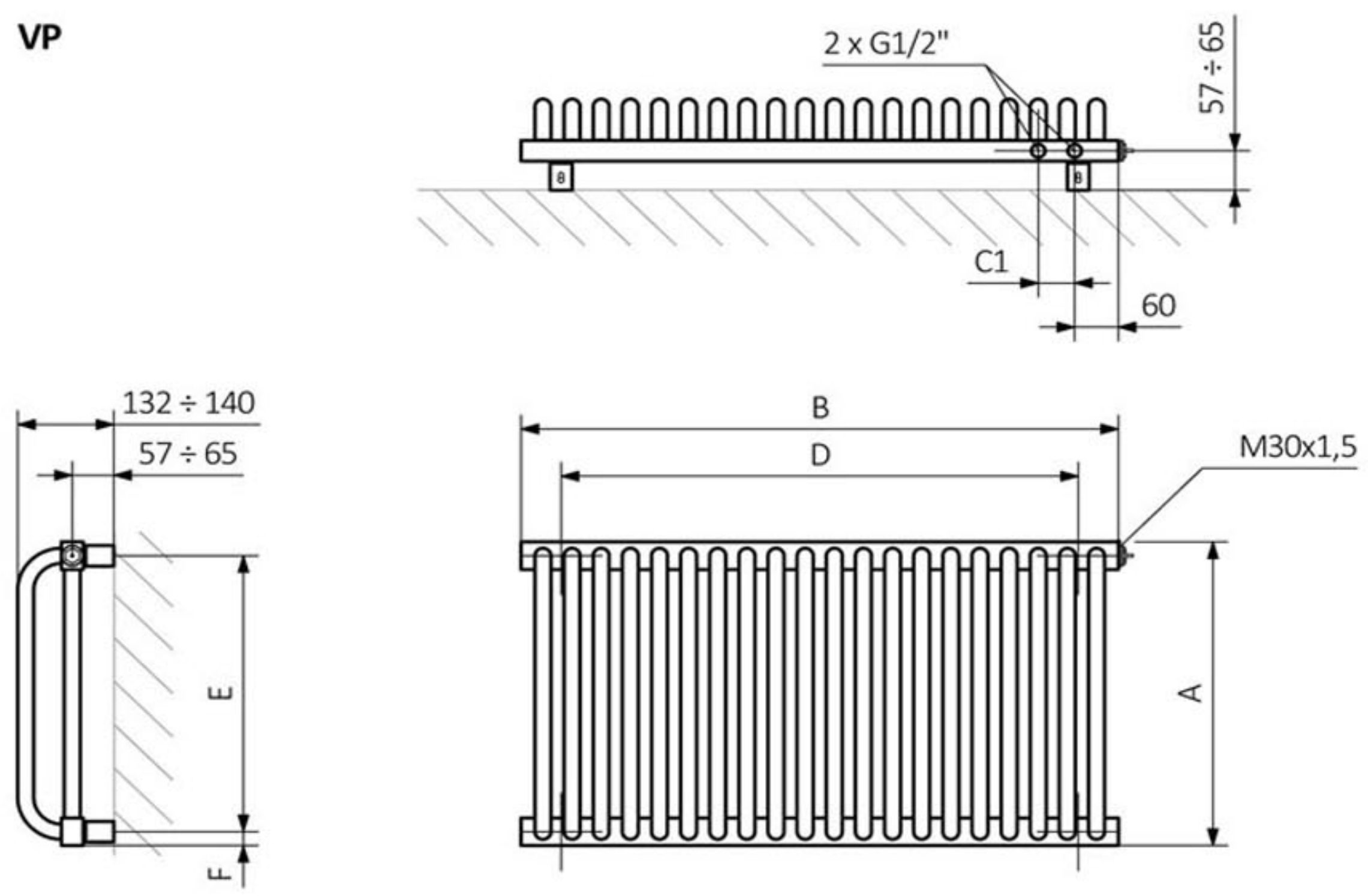

Delfin

Preisliste



Modell	Höhe mm.	Breite mm.	Elektrisch mit Heizparone	
			Farbe	DRY / MEG / MOA
Delfin	440	820	536 €	621 €
Delfin	440	1020	588 €	673 €
Delfin	440	1220	655 €	740 €
Delfin	540	820	547 €	632 €
Delfin	540	1020	621 €	706 €
Delfin	540	1220	760 €	845 €
Delfin	640	820	668 €	753 €
Delfin	640	1020	760 €	845 €
Delfin	640	1220	852 €	937 €
Delfin	1800	500	1.080 €	
Delfin	1800	580	1.230 €	
Delfin	2000	500	1.200 €	
Delfin	2000	580	1.380 €	

Inkl. 19% MwSt.

zuzüglich 15,00 € Versandkosten.

Gewährleistung: 5 Jahre

Anschlussmöglichkeiten: siehe Datenblatt

Lieferzeit ca. 6 Wochen ab Zahlungseingang

Bei Bestellungen oder Nachfragen, schreiben Sie uns
eine Mail an: info@badheizkoerper-berlin.de

Badheizkörper-Berlin

Gerlinger Str. 34

12349 Berlin

Tel.: +49 (30) 658 30975

Mobil: +49 (177) 248 63 14

info@badheizkoerper-berlin.de

www.badheizkoerper-berlin.de